

Chip Beads(SMD) For Signal Line

Conformity to RoHS Directive

MMZ Series MMZ1005 Type

FEATURES

- Size standardized for use by automatic assembly equipment. No preferred orientation.
- Electroplated terminal electrodes accommodate reflow soldering.
- High reliability due to an entirely monolithic structure.
- Closed magnetic circuit structure allows high-density installation while preventing crosstalk between circuits.
- Low DC resistance structure of electrode prevents wasteful electric power consumption.
- It is a product conforming to RoHS directive.

APPLICATIONS

Personal computers, CRTs, liquid crystal display panels, printers, hard disk drives, game machines, cellular phones, etc.

PRODUCT IDENTIFICATION

MMZ	1005	S	121	C	T
(1)	(2)	(3)	(4)	(5)	(6)

- (1) Series name
 (2) Dimensions L×W
 (3) Material code
 (4) Nominal impedance
 121:120Ω at 100MHz
 (5) Characteristic type
 (6) Packaging style
 T:Taping

HANDLING AND PRECAUTIONS

- Before soldering, be sure to preheat components. The preheating temperature should be set so that the temperature difference between the solder temperature and product temperature does not exceed 150°C.
- After mounting components onto the printed circuit board, do not apply stress through board bending or mishandling.
- Do not expose the inductors to stray magnetic fields.
- Avoid static electricity discharge during handling.
- When hand soldering, apply the soldering iron to the printed circuit board only. Temperature of the iron tip should not exceed 350°C. Soldering time should not exceed 3 seconds.

MATERIAL CHARACTERISTICS

B material: This type is perfectly suited for fast digital signals. By equalizing R components and X components that beads possess at a frequency of 5MHz, it is able to suppress overshooting, undershooting and ringing of fast digital signals.

S material: Standard type that features impedance characteristics similar to those of a typical ferrite core. For signal line applications in which the blocking region is near 100MHz. Impedance values selected for effectiveness at 40 to 300MHz.

Y material: High frequency range type intended for the 100MHz region and above. For signal line applications in which the signal frequency is far from the cutoff frequency. Impedance values selected for effectiveness at 80 to 400MHz.

D material: For applications calling for low insertion loss at low frequencies and sharply increasing impedance at high frequencies. Designed for high impedance at high frequencies (300MHz to 1GHz) for signal line applications.

F material: This new product inherits the characteristic of our D-material, namely its sharp impedance rise time, and its impedance peak frequency has been shifted higher into range. The product offers excellent noise suppression from 600MHz to as high as in the GHz range.

TYPICAL MATERIAL CHARACTERISTICS

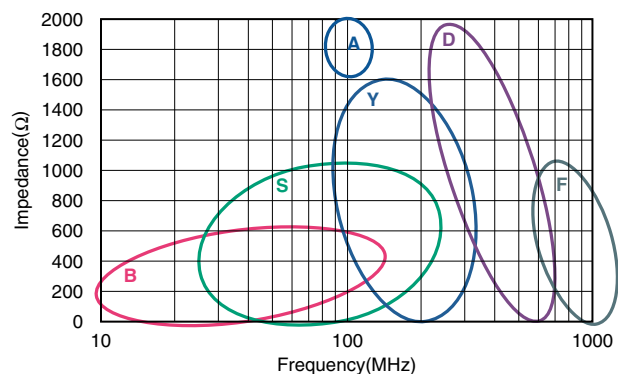

• Conformity to RoHS Directive: This means that, in conformity with EU Directive 2002/95/EC, lead, cadmium, mercury, hexavalent chromium, and specific bromine-based flame retardants, PBB and PBDE, have not been used, except for exempted applications.

• Please contact our Sales office when your application are considered the following:
 The device's failure or malfunction may directly endanger human life (e.g. application for automobile/aircraft/medical/nuclear power devices, etc.)

• All specifications are subject to change without notice.

SHAPES AND DIMENSIONS/RECOMMENDED PC BOARD PATTERN

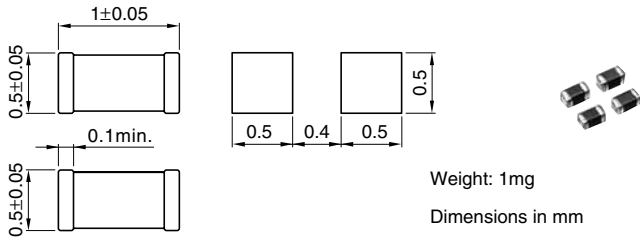

TEMPERATURE RANGES

Operating/storage	-55 to +125°C
-------------------	---------------

PACKAGING STYLE AND QUANTITIES

Packaging style	Quantity
Taping	10000 pieces/reel

RECOMMENDED SOLDERING CONDITION REFLOW SOLDERING

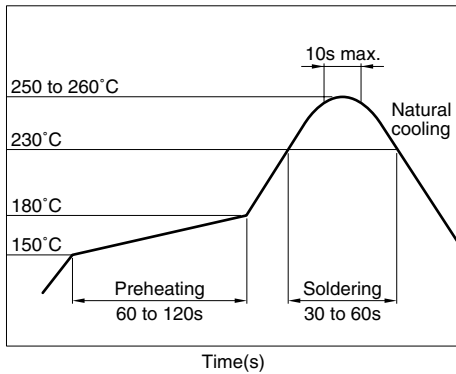

ELECTRICAL CHARACTERISTICS

Part No.	Impedance (Ω)[100MHz]*	DC resistance (Ω)max.	Rated current (mA)max.
MMZ1005B800C	80±25%	0.2	450
MMZ1005B121C	120±25%	0.25	400
MMZ1005B601C	600±25%	0.85	200
MMZ1005S800C	80±25%	0.2	500
MMZ1005S121C	120±25%	0.25	500
MMZ1005S241C	240±25%	0.4	400
MMZ1005S601C	600±25%	0.6	300
MMZ1005S102C	1000±25%	1	200
MMZ1005Y400C	40±25%	0.12	550
MMZ1005Y800C	80±25%	0.17	450
MMZ1005Y121C	120±25%	0.21	400
MMZ1005Y241C	240±25%	0.33	300
MMZ1005Y301C	300±25%	0.38	250
MMZ1005Y471C	470±25%	0.5	250
MMZ1005Y601C	600±25%	0.56	250
MMZ1005Y102C	1000±25%	0.74	200
MMZ1005Y152C	1500±25%	1.15	100
MMZ1005A152E	1500±25%	2	100
MMZ1005D100C	10±5Ω	0.1	500
MMZ1005D220C	22±25%	0.2	400
MMZ1005D330C	33±25%	0.35	400
MMZ1005D680C	68±25%	0.55	400
MMZ1005D121C	120±25%	0.75	350
MMZ1005D241C	240±25%	1.2	200
MMZ1005F330C	33±25%	0.6	200
MMZ1005F470C	47±25%	0.8	100
MMZ1005F560C	56±25%	0.8	100

* Test equipment: E4991A or equivalent
Test tool: 16192A or equivalent
Test temperature: 25±10°C

TYPICAL ELECTRICAL CHARACTERISTICS Z, X, R vs. FREQUENCY CHARACTERISTICS

MMZ1005B800C

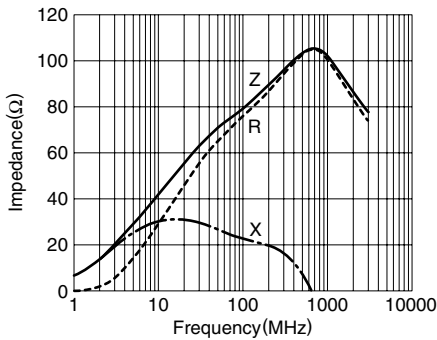

MMZ1005B121C

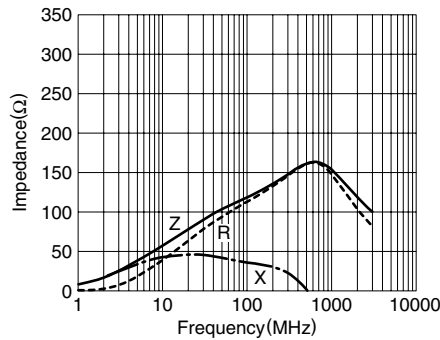

MMZ1005B601C

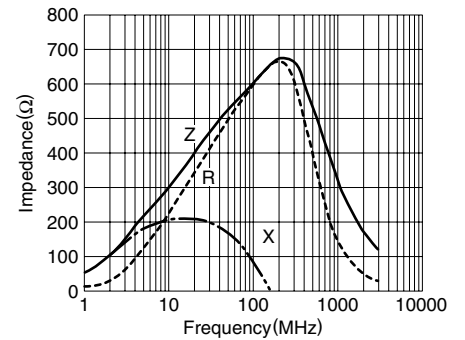

MMZ1005S800C

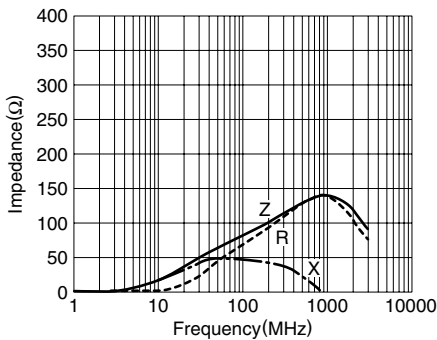

MMZ1005S121C

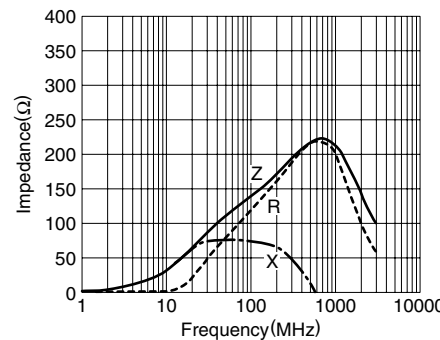

MMZ1005S241C

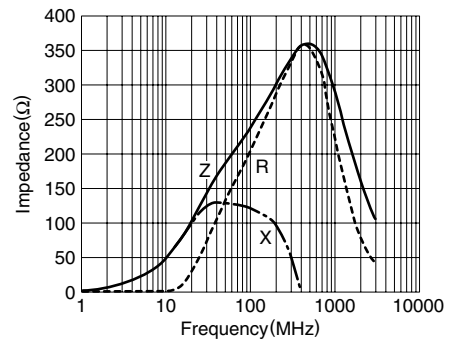

• All specifications are subject to change without notice.

TYPICAL ELECTRICAL CHARACTERISTICS

Z, X, R vs. FREQUENCY CHARACTERISTICS

MMZ1005S601C

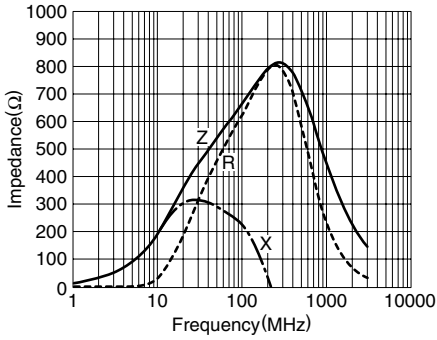

MMZ1005S102C

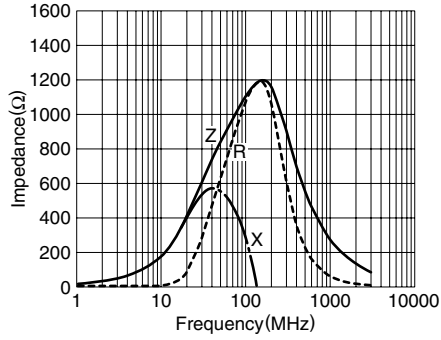

MMZ1005Y400C

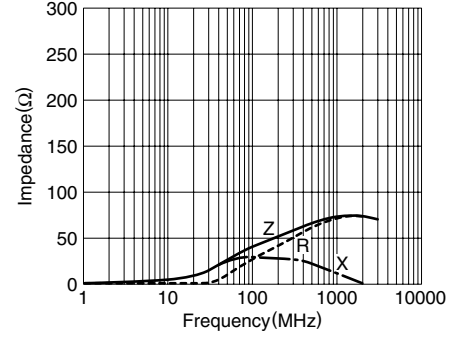

MMZ1005Y800C

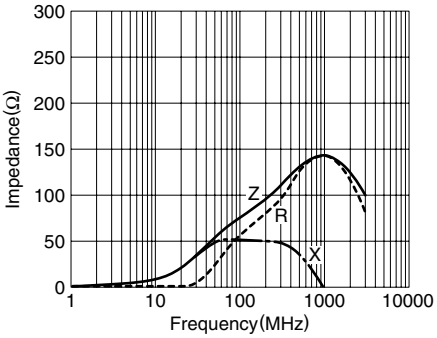

MMZ1005Y121C

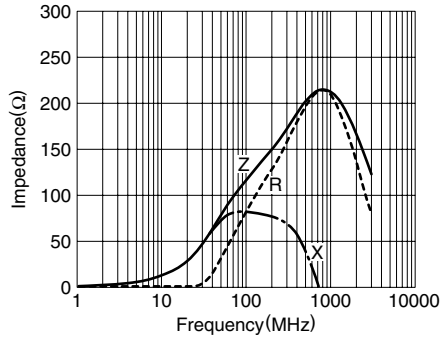

MMZ1005Y241C

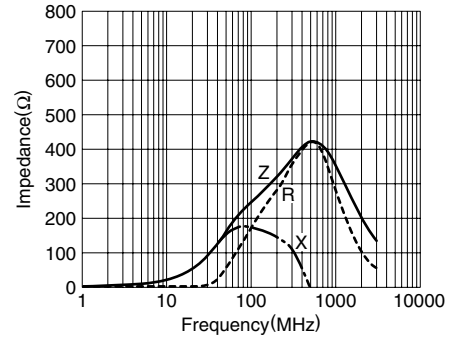

MMZ1005Y301C

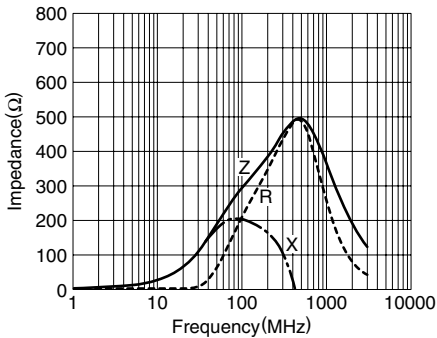

MMZ1005Y471C

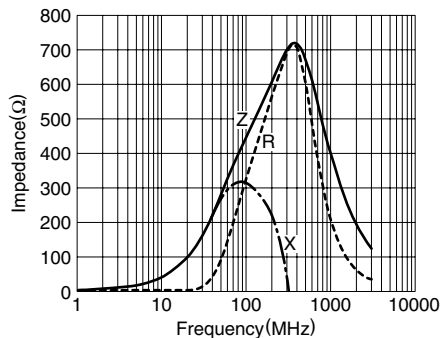

MMZ1005Y601C

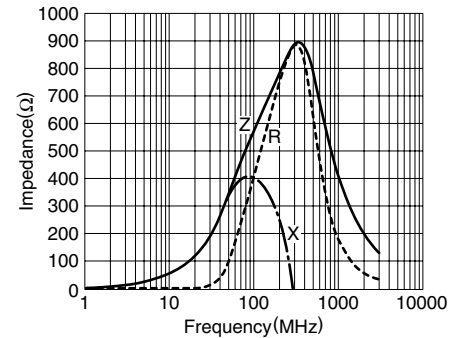

MMZ1005Y102C

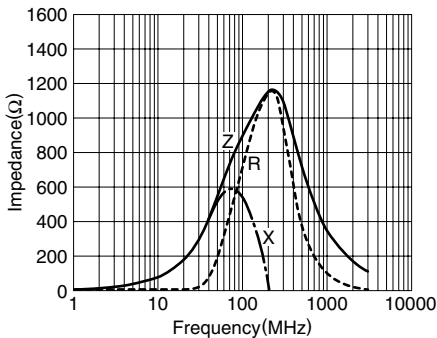

MMZ1005Y152C

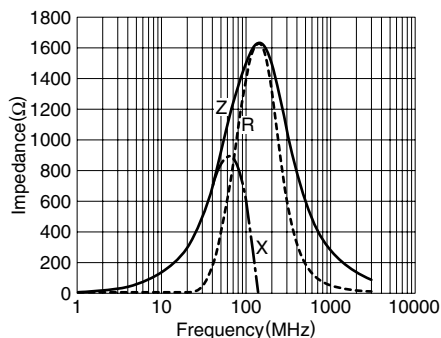

MMZ1005A152E

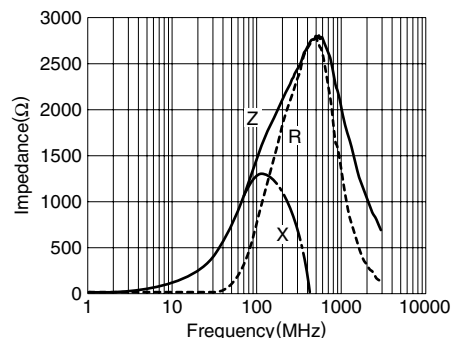

• All specifications are subject to change without notice.

TYPICAL ELECTRICAL CHARACTERISTICS

Z, X, R vs. FREQUENCY CHARACTERISTICS

MMZ1005D100C

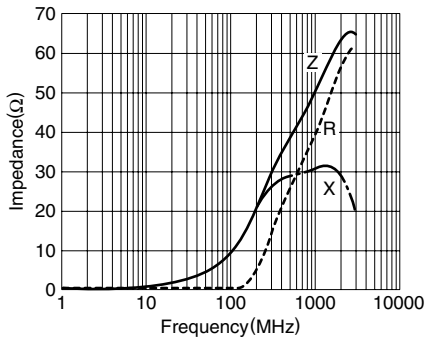

MMZ1005D220C

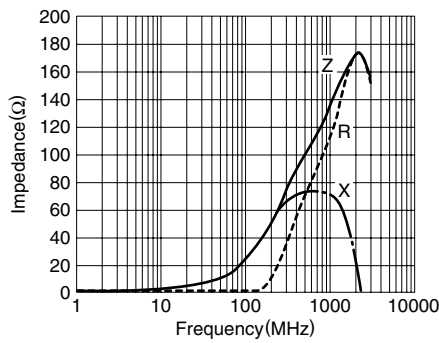

MMZ1005D330C

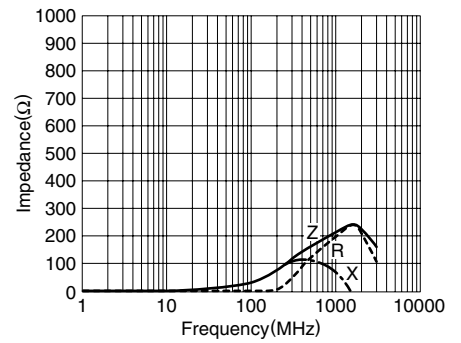

MMZ1005D680C

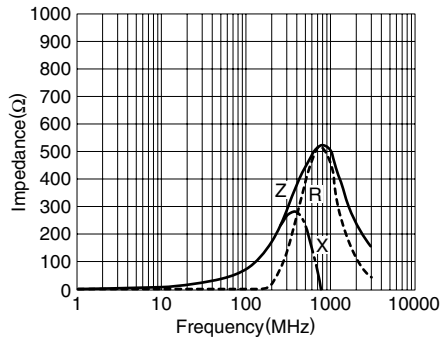

MMZ1005D121C

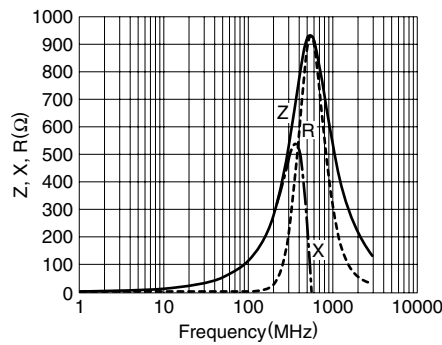

MMZ1005D241C

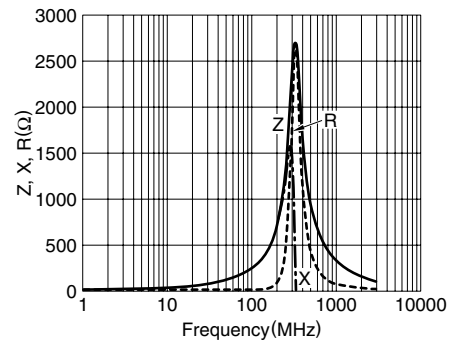

MMZ1005F330C

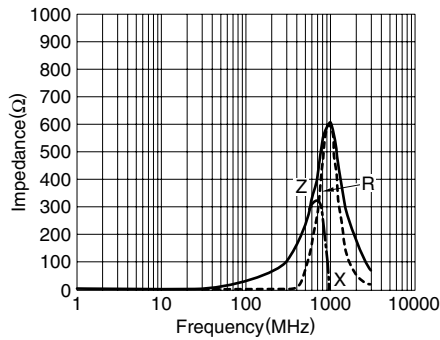

MMZ1005F470C

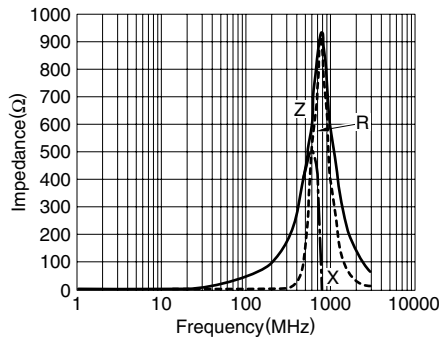

MMZ1005F560C

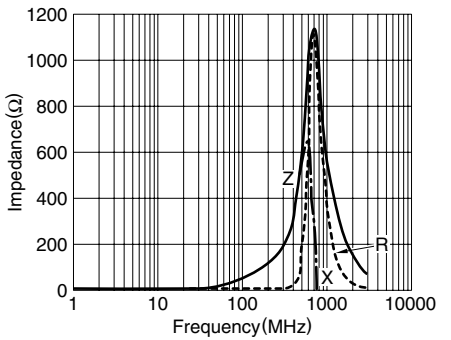

PACKAGING STYLES

REEL DIMENSIONS

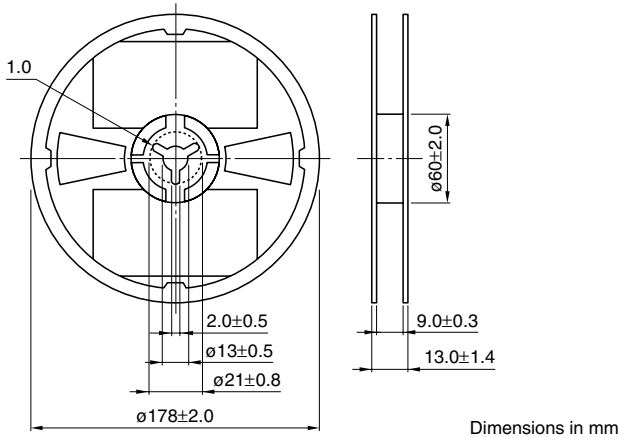

Dimensions in mm

TAPE DIMENSIONS

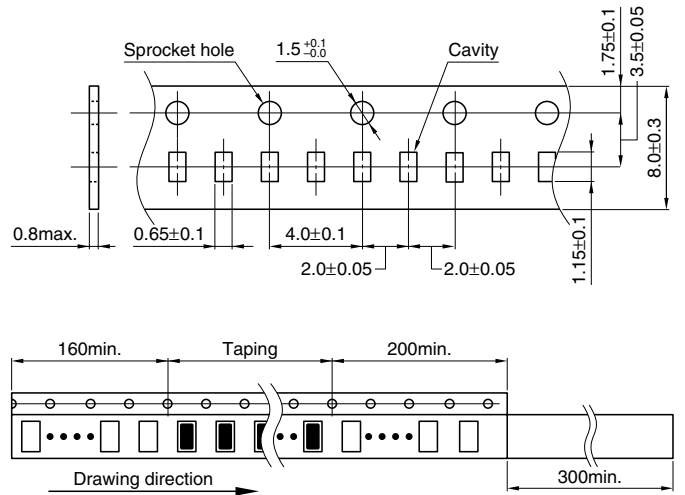

Dimensions in mm

• All specifications are subject to change without notice.